

Description

LH PACKAGING Stand Alone Vacuum Packaging Machines can be used in a mobile fashion thanks to their movable floor stands and allow for fast relocations. They are also suitable for packaging larger products. It's easy to operate, clean and service. The machines can be equipped with pumps with varying outputs according to individual requirement. The gas flushing processes to guarantee a reproducible packing quality.

LH Stand Alone Vacuum Packaging Machines Series constructed of a high-quality stainless steel. It's easy to operate, clean and maintain. The gas flushing function is option.

Technical Characters

1. Control System: The PLC control panel provides several control modes for user's selection.
2. Material of Main Structure: 304 stainless steel.
3. Hinges on Lid: The special labor-saving hinges on the lid markedly reduce the labor intensity of operator in dally work, so that they handle it withease.
4. "V" Lid Gasket: The "V" shaped vacuum chamber lid gasket made of high-density material guarantees the sealing performance of the machine in routine work. The compression and wearing resistance of the material extends the service life of the lid gasket and reduce its changing frequency.
5. Electrical requirement and plug could be custom according to customer requirement.
6. Gas flushing is optional.
7. Insert plate is optional.

Machine Dimensions Drawing

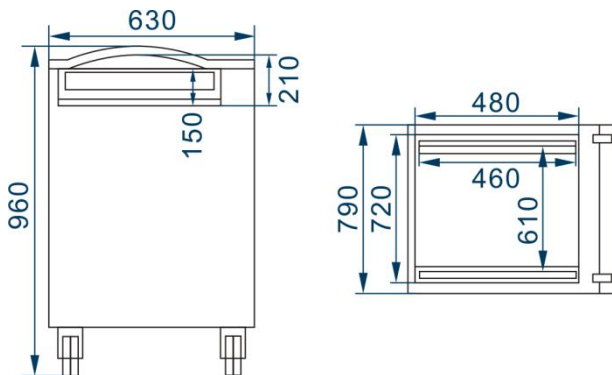

LH-460/2G

STAND ALONE VACUUM PACKAGING MACHINE

Technical Specifications					
Model	LH-460/2G	Vacuum Pump (m ³ /h)	20	Production Cycle (times/min)	2
Machine Dimensions (mm)	790×630×960	Power (kw)	0.75	Gross Weight (kg)	150
Chamber Dimensions (mm)	720×480×210(150)	Voltage (v)	1P/220	Net Weight (kg)	121
Sealer Dimensions (mm)	460×8×2	Frequency (Hz)	50	Shipping Dimensions (mm)	870×690×1140

Data in parentheses indicates height of vacuum chamber